

## Kostenvoranschlag

Absender / Rechnungsadresse

## Bestellung

Versandadresse

Besteller

Datum

Kommission



Abbildung entspricht nicht der Grundausrüstung | Maßtoleranzen ±3%

### Grundausrüstung Typ 108

- Schwenkarmbeckenrahmen
- Standfüße
- Fußschalen
- Kniepelotten
- Beckenpelotten
- Therapietisch

### Grundausrüstung Typ 102 / 101

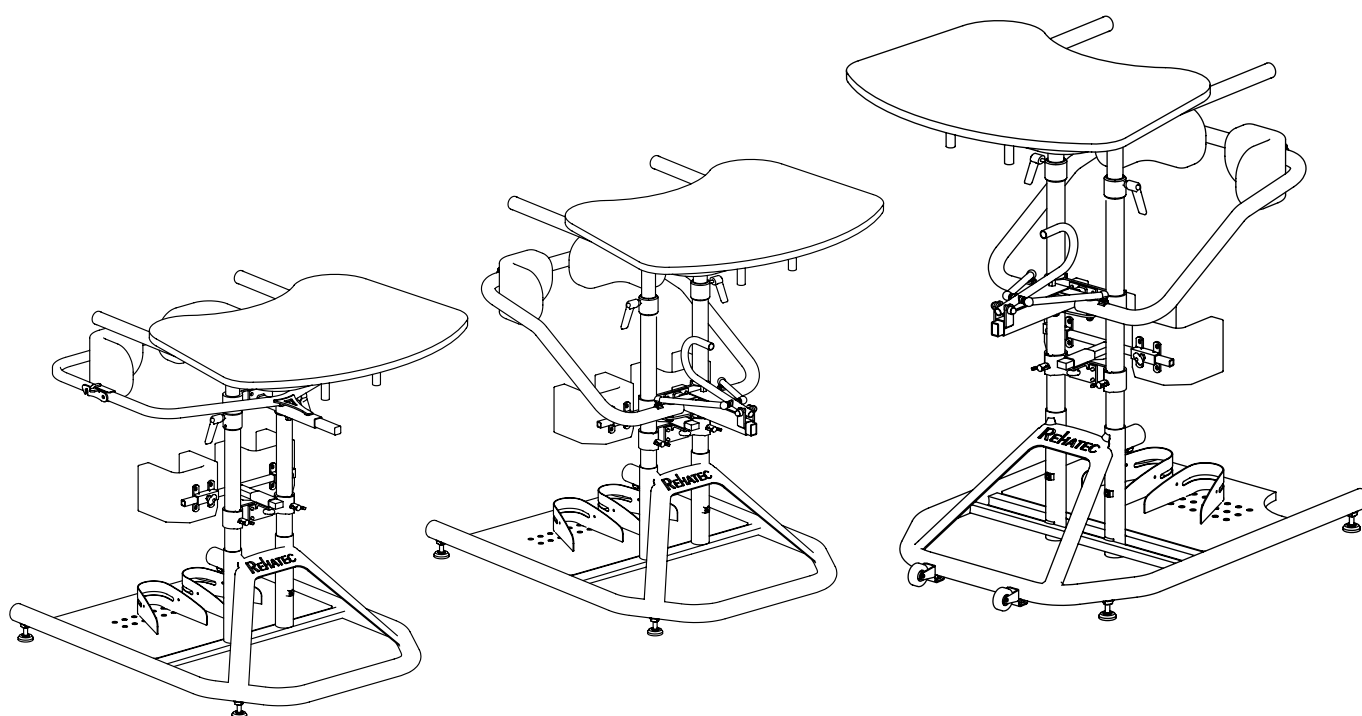
- Scherenbeckenrahmen
- Standfüße
- Fußschalen
- Kniepelotten
- Beckenpelotten
- Therapietisch

**Scherenbeckenrahmen  
erst ab einer Tischhöhe  
von 75 cm möglich!**

### Typen

- |                                 |        |
|---------------------------------|--------|
| • Typ 108 Max. Benutzergewicht: | 40 kg  |
| Max. Tischhöhe:                 | 65 cm  |
| • Typ 102 Max. Benutzergewicht: | 100 kg |
| Max. Tischhöhe:                 | 90 cm  |
| • Typ 101 Max. Benutzergewicht: | 100 kg |
| Max. Tischhöhe:                 | 115 cm |

### Hilfsmittelnummer

- |                      |               |
|----------------------|---------------|
| Typ 108 (mit Rollen) | 28.29.01.1018 |
| (ohne Rollen)        | 28.29.01.0014 |
| Typ 102 (mit Rollen) | 28.29.01.1017 |
| (ohne Rollen)        | 28.29.01.0013 |
| Typ 101 (mit Rollen) | 28.29.01.1016 |
| (ohne Rollen)        | 28.29.01.0012 |

Weitere technische Daten finden Sie auf [www.rehatec.com](http://www.rehatec.com) -> Downloads. Oder fordern Sie diese einfach per eMail, FAX oder Post an!

Preise gültig bis 31.12.2019. Preise zzgl. ges. MwSt. © Vervielfältigung nur mit Genehmigung der Rehatec Dieter Frank GmbH erlaubt.

Technische Änderungen vorbehalten. Es gelten unsere Allgemeinen Geschäftsbedingungen. Diese finden Sie auf [www.rehatec.com](http://www.rehatec.com).

Mit einer Bestellung bestätigen Sie automatisch unsere AGB gelesen und akzeptiert zu haben.

Rehatec® Dieter Frank GmbH, In den Kreuzwiesen 35, 69250 Schönau, Tel. (06228) 9136-0, Fax. (06228) 9136-99, [info@rehatec.com](mailto:info@rehatec.com), [www.rehatec.com](http://www.rehatec.com)

Trage unten die Maße deines Patienten ein.

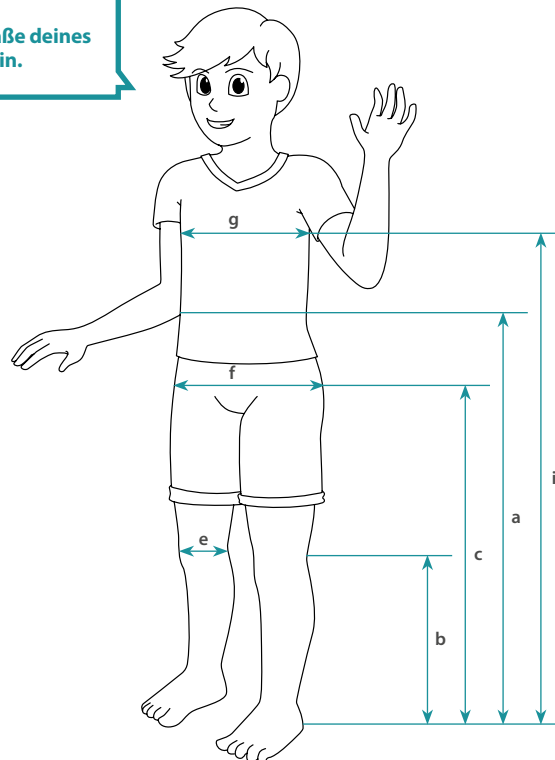

Maßtoleranzen  $\pm 3\%$

## Patientenmaße

Tischhöhe (a)	Kniehöhe (b)	Höhe Beckenmitte (c)	Kniebreite (e)	Beckenbreite (f)	Brustkorbbreite (g)	Brustpelotenhöhe (i)
cm	cm	cm	cm	cm	cm	cm

## Gerätemaße

Typ	Maximale Tischhöhe	Minimale Tischhöhe		Untergestelllänge		Untergestellbreite	
		Schwenkarmbeckenr. <sup>(1)</sup>	Scherenbeckenr. <sup>(2)</sup>	Standard	Multi	Innen	Außen
108	65 cm	50 cm	—	84 cm	100 cm	49 cm	56 cm
102	90 cm	50 cm	75 cm	84 cm	100 cm	49 cm	56 cm
101	115 cm	70 cm	75 cm	95 cm	110 cm	60 cm	69 cm

Typ	Tischaufnahme Innenbreite	Rahmeninnenbreite		Minimale Rahmenhöhe		max. Benutzer-gewicht
		Schwenkarmbeckenr.	Scherenbeckenr.	Schwenkarmbeckenr.	Scherenbeckenr.	
108	43,5 cm	33 cm	—	38 cm	—	40 kg
102	43,5 cm	41 cm	41 cm	38 cm	62 cm	100 kg
101	43,5 cm	51 cm	45 cm	58 cm	62 cm	100 kg

## Pelottenmaße

Typ	Min. Kniepelotenhöhe	Brustpelotte (B×H)	Seitenführungs-pelotten (B×H)	Brustkorb-breite	Rückenpelotte (B×H)	Beckenpelotte (B×H)	Beckenbreite	
							Schwenka.	Scherenb.
108	17 cm	24×27 cm	12×17 cm	13-28 cm	22×22 cm	11×11 cm	19-26 cm	—
102	22 cm	24×32 cm	14×20 cm	19-33 cm	22×22 cm	12×12 cm	24-34 cm	24-34 cm
101	28 cm	30×37 cm	14×20 cm	22-37 cm	27×27 cm	15×13 cm	30-44 cm	30-38 cm

<sup>(1)</sup> bei minimalster Tischhöhe keine Höhenverstellung für Brustpelotte oder Schwenkarmbeckenrahmen möglich | <sup>(2)</sup> Brustpelotte muss auf höchster Einstellung stehen, damit sich der Hebel betätigen lässt. Keine Höheneinstellung für Brust-/Kniepelotte und Scherenbeckenrahmen möglich!

Weitere technische Daten finden Sie auf [www.rehatec.com](http://www.rehatec.com) -> Downloads. Oder fordern Sie diese einfach per eMail, FAX oder Post an!









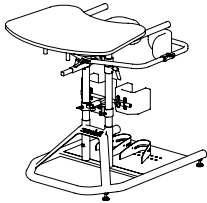
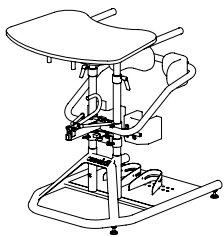
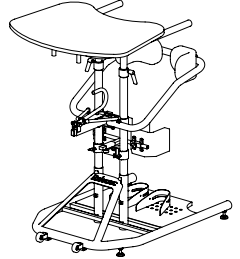

























































Preise gültig bis 31.12.2019. Preise zzgl. ges. MwSt. © Vervielfältigung nur mit Genehmigung der Rehatec Dieter Frank GmbH erlaubt.



Technische Änderungen vorbehalten. Es gelten unsere Allgemeinen Geschäftsbedingungen. Diese finden Sie auf [www.rehatec.com](http://www.rehatec.com).

Mit einer Bestellung bestätigen Sie automatisch unsere AGB gelesen und akzeptiert zu haben.

Rehatec® Dieter Frank GmbH, In den Kreuzwiesen 35, 69250 Schönau, Tel. (06228) 9136-0, Fax. (06228) 9136-99, info@rehatec.com, www.rehatec.com

Variante					
<b>Typ 108 für Kleinkinder</b>  Bezugsfarbe: Skai Blau Atoll	<b>Typ 102 für Kinder und Jugendliche</b>  Bezugsfarbe: Skai Blau Atoll	<b>Typ 101 für Erwachsene</b>  Bezugsfarbe: Skai Blau Atoll			
<b>Grundpreis</b>	<b>2.704,-€</b>	<b>Grundpreis</b>	<b>2.601,-€</b>	<b>Grundpreis</b>	<b>2.601,-€</b>

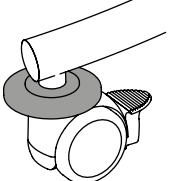
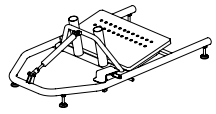
Gestellfarben																																																	
<table border="0"> <tr> <td></td> <td>Reinweiß (RAL 9010)</td> <td></td> <td>Bordeauxviolett (RAL 4004)</td> <td></td> <td>Leuchtgrün (RAL 6038)</td> </tr> <tr> <td></td> <td>Narzissengelb (RAL 1007)</td> <td></td> <td>Ultramarinblau (RAL 5002)</td> <td></td> <td>Anthrazitgrau matt (RAL 7016m)</td> </tr> <tr> <td></td> <td>Leuchtgelb (RAL 1026)</td> <td></td> <td>Verkehrsblau metallic</td> <td></td> <td>Silber metallic</td> </tr> <tr> <td></td> <td>Reinorange (RAL 2004)</td> <td></td> <td>Perlnachtblau (RAL 5026)</td> <td></td> <td>Anthrazit metallic</td> </tr> <tr> <td></td> <td>Leuchtorange (RAL 2005)</td> <td></td> <td>Wasserblau (RAL 5021)</td> <td></td> <td>Graphitschwarz matt (RAL 9011m)</td> </tr> <tr> <td></td> <td>Rubinrot (RAL 3003)</td> <td></td> <td>Lichtgrün (RAL 6027)</td> <td></td> <td>Tiefschwarz glanz (RAL 9005g)</td> </tr> <tr> <td></td> <td>Perlrubinrot (RAL 3032)</td> <td></td> <td>Gelbgrün (RAL 6018)</td> <td></td> <td></td> </tr> <tr> <td></td> <td>Erikaviolett (RAL 4003)</td> <td></td> <td>Perlgrün (RAL 6035)</td> <td></td> <td></td> </tr> </table>		Reinweiß (RAL 9010)		Bordeauxviolett (RAL 4004)		Leuchtgrün (RAL 6038)		Narzissengelb (RAL 1007)		Ultramarinblau (RAL 5002)		Anthrazitgrau matt (RAL 7016m)		Leuchtgelb (RAL 1026)		Verkehrsblau metallic		Silber metallic		Reinorange (RAL 2004)		Perlnachtblau (RAL 5026)		Anthrazit metallic		Leuchtorange (RAL 2005)		Wasserblau (RAL 5021)		Graphitschwarz matt (RAL 9011m)		Rubinrot (RAL 3003)		Lichtgrün (RAL 6027)		Tiefschwarz glanz (RAL 9005g)		Perlrubinrot (RAL 3032)		Gelbgrün (RAL 6018)				Erikaviolett (RAL 4003)		Perlgrün (RAL 6035)			
	Reinweiß (RAL 9010)		Bordeauxviolett (RAL 4004)		Leuchtgrün (RAL 6038)																																												
	Narzissengelb (RAL 1007)		Ultramarinblau (RAL 5002)		Anthrazitgrau matt (RAL 7016m)																																												
	Leuchtgelb (RAL 1026)		Verkehrsblau metallic		Silber metallic																																												
	Reinorange (RAL 2004)		Perlnachtblau (RAL 5026)		Anthrazit metallic																																												
	Leuchtorange (RAL 2005)		Wasserblau (RAL 5021)		Graphitschwarz matt (RAL 9011m)																																												
	Rubinrot (RAL 3003)		Lichtgrün (RAL 6027)		Tiefschwarz glanz (RAL 9005g)																																												
	Perlrubinrot (RAL 3032)		Gelbgrün (RAL 6018)																																														
	Erikaviolett (RAL 4003)		Perlgrün (RAL 6035)																																														
<b>Farbdarstellungen nur als Übersicht. Alle Farbdetails auf <a href="http://www.rehatec.com">www.rehatec.com</a></b>																																																	

Gestell									
<b>Transportrollen mit Feststellbremsen, 75 mm</b> Code 10003 	<b>Wand- und Möbelschutz</b> Code 1018607 	<b>Untergestell Multi</b> inkl. Tischplattenschrägverstellung Gestell kantelbar bis 20°  <table border="1"> <tr> <th>Code</th> <th>Für Typ</th> </tr> <tr> <td>112</td> <td>108 / 102</td> </tr> <tr> <td>113</td> <td>101</td> </tr> </table>	Code	Für Typ	112	108 / 102	113	101	<b>Tiefer Einstieg</b> Code 119 Standardeinstiegshöhe = 14 cm Tiefe Einstiegshöhe = 9 cm  <div style="border: 1px solid black; padding: 5px; text-align: center;"><b>Nur in Verbindung mit Transportrollen möglich!</b></div>
Code	Für Typ								
112	108 / 102								
113	101								
<b>Satz</b>	<b>223,-€</b>	<b>Satz</b>	<b>92,-€</b>	<b>Aufpreis</b>	<b>324,-€</b>	<b>Aufpreis</b>	<b>436,-€</b>		

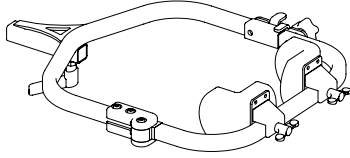
Beckenrahmen							
<b>Schwenkarmbeckenrahmen</b>							
							
<table border="1"> <tr> <th>Code</th> <th>Beckenbreite</th> </tr> <tr> <td>116</td> <td>24 - 34 cm</td> </tr> <tr> <td>115<sup>(1)</sup></td> <td>30 - 44 cm</td> </tr> </table>	Code	Beckenbreite	116	24 - 34 cm	115 <sup>(1)</sup>	30 - 44 cm	<b>Standard bei Typ 108</b>
Code	Beckenbreite						
116	24 - 34 cm						
115 <sup>(1)</sup>	30 - 44 cm						
<b>Aufpreis</b>	<b>211,-€</b>						

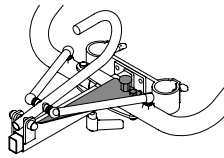
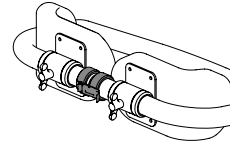
Scherenbeckenrahmen Sicherungen			
<b>Sicherung am Hebel</b> Code 10001 	<b>Sicherung am hinteren Rahmen</b> Code 1004375 		
<b>Nicht für Schwenkarmbeckenrahmen möglich!</b>	<b>Nicht für Schwenkarmbeckenrahmen möglich!</b>		
<b>Stück</b>	<b>83,-€</b>	<b>Satz</b>	<b>101,-€</b>

<sup>(1)</sup> ab Gr. 102 empfohlen

Weitere technische Daten finden Sie auf [www.rehatec.com](http://www.rehatec.com) -> Downloads. Oder fordern Sie diese einfach per eMail, FAX oder Post an!

Preise gültig bis 31.12.2019. Preise zzgl. ges. MwSt. © Vervielfältigung nur mit Genehmigung der Rehatec Dieter Frank GmbH erlaubt.

Technische Änderungen vorbehalten. Es gelten unsere Allgemeinen Geschäftsbedingungen. Diese finden Sie auf [www.rehatec.com](http://www.rehatec.com).

Mit einer Bestellung bestätigen Sie automatisch unsere AGB gelesen und akzeptiert zu haben.

Rehatec® Dieter Frank GmbH, In den Kreuzwiesen 35, 69250 Schönau, Tel. (06228) 9136-0, Fax. (06228) 9136-99, info@rehatec.com, www.rehatec.com

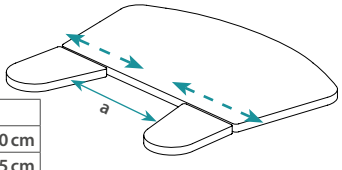
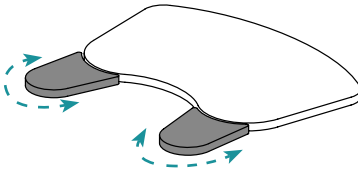
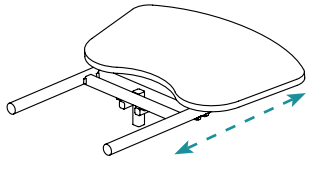
Therapietisch					
<b>Parallelverstellbare Armauflagen, inkl. geradem Tisch</b>		<b>Armauflagen für Standardtisch</b> Code 10026	<b>Tischtiefenverstellung</b> Code 10015		
In der Breite verstellbar		In der Breite verstellbar			
					
Code	Für Typ	a			
1016764	108	19–30 cm			
1018739	102	24–35 cm			
1017874	101	35–46 cm			
<b>Paar</b>		<b>168,-€</b>	<b>Paar</b>	<b>168,-€</b>	<b>Aufpreis</b> <b>226,-€</b>

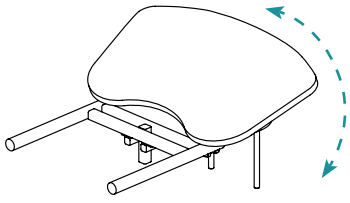
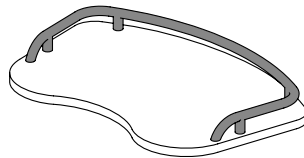
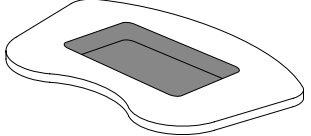
<b>Tischplattenschrägverstellung</b> Code 10056	<b>Tischumrandung</b> Code 10011	<b>Therapiemulde mit Deckel</b> Code 10057
		
<b>Bei Untergestell Multi inklusive</b>		
<b>Aufpreis</b> <b>118,-€</b>	<b>Satz</b> <b>132,-€</b>	<b>Stück</b> <b>260,-€</b>

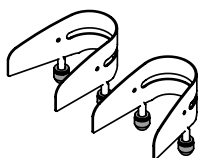
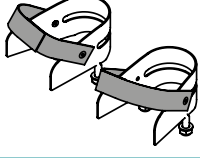
Fußschalen		Fußriemen	
<b>Fußschalen verschraubbar</b> Code 10027	<b>Fußriemen</b> Code 10006		
			
	<b>Empfohlen bei verschraubbaren Fußschalen</b>		
<b>Paar / Aufpreis</b> <b>57,-€</b>	<b>Paar</b> <b>40,-€</b>		

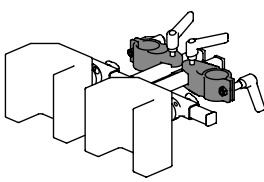
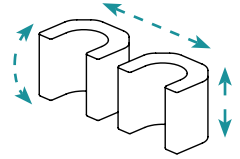
Kniepelottenmechanik	
<b>Einzel verstellbare Kniepelotten</b> Code 10019	<b>Kniepelotten in 3 Ebenen verstellbar</b> Code 10022
	
<b>Paar / Aufpreis</b> <b>180,-€</b>	<b>Paar / Aufpreis</b> <b>168,-€</b>

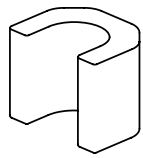
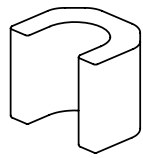
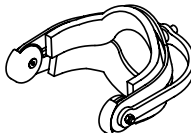
Kniepelotten		
<b>Standard Kniepelotten</b>	<b>Kniepelotten nach Maß</b> Code 10045-2	<b>Anatomische Kniepelotten</b> Code 10033
		
<b>Maß richtet sich nach Patientenmaß (6–13 cm)</b>	e-Maß = _____ cm (ab 14 cm)	8 cm 11,5 cm 13 cm
<b>Standard</b>	<b>Paar / Aufpreis</b> <b>159,-€</b>	<b>Paar / Aufpreis</b> <b>84,-€</b>

Weitere technische Daten finden Sie auf [www.rehatec.com](http://www.rehatec.com) -> Downloads. Oder fordern Sie diese einfach per eMail, FAX oder Post an!

Preise gültig bis 31.12.2019. Preise zzgl. ges. MwSt. © Vervielfältigung nur mit Genehmigung der Rehatec Dieter Frank GmbH erlaubt.

Technische Änderungen vorbehalten. Es gelten unsere Allgemeinen Geschäftsbedingungen. Diese finden Sie auf [www.rehatec.com](http://www.rehatec.com).

Mit einer Bestellung bestätigen Sie automatisch unsere AGB gelesen und akzeptiert zu haben.

Rehatec® Dieter Frank GmbH, In den Kreuzwiesen 35, 69250 Schönau, Tel. (06228) 9136-0, Fax. (06228) 9136-99, [info@rehatec.com](mailto:info@rehatec.com), [www.rehatec.com](http://www.rehatec.com)

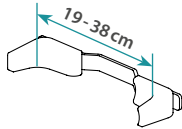
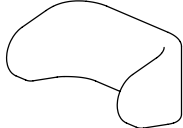
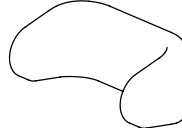
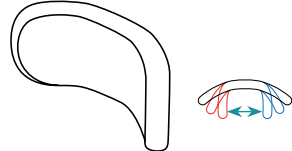
Pelotten												
<b>Spinenpelotten</b> Code 10020  f-Maß = _____ cm <div style="border: 1px solid black; padding: 2px; display: inline-block;"><b>Nicht bei Typ 108!</b></div>	<b>Brustpelotte, gebogene Form</b> Code 10008-1  g-Maß: 15 cm 17 cm	<b>Brustpelotte, nach Maß</b> Code 10008-3  g-Maß = _____ cm	<b>Brustpelotte, stufenlos verstellbar</b>  <table border="1"> <thead> <tr> <th>Code</th> <th>Brustkorbbreite</th> <th>Höhe</th> </tr> </thead> <tbody> <tr> <td>10008-4</td> <td>17 - 30 cm</td> <td>15 cm</td> </tr> <tr> <td>10008-X</td> <td>10 - 26 cm</td> <td>10 cm</td> </tr> </tbody> </table>	Code	Brustkorbbreite	Höhe	10008-4	17 - 30 cm	15 cm	10008-X	10 - 26 cm	10 cm
Code	Brustkorbbreite	Höhe										
10008-4	17 - 30 cm	15 cm										
10008-X	10 - 26 cm	10 cm										
<b>Stück</b> 332,-€	<b>Stück</b> 199,-€	<b>Stück</b> 245,-€	<b>Stück</b> 371,-€									

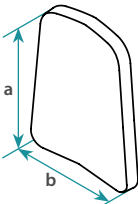
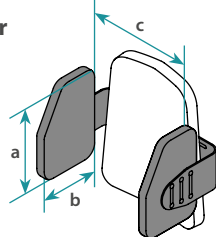
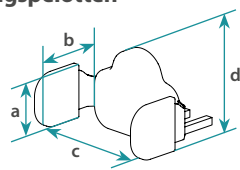
<b>Brustpelotte</b> Code 10008-2  <table border="1"> <thead> <tr> <th>Für Gr.</th> <th>a</th> <th>b</th> </tr> </thead> <tbody> <tr> <td>108</td> <td>27 cm</td> <td>24 cm</td> </tr> <tr> <td>102</td> <td>32 cm</td> <td>24 cm</td> </tr> <tr> <td>101</td> <td>37 cm</td> <td>30 cm</td> </tr> </tbody> </table>	Für Gr.	a	b	108	27 cm	24 cm	102	32 cm	24 cm	101	37 cm	30 cm	<b>Seitenführungspelotten, höhen- und breitenverstellbar</b> Code 10017-2  <table border="1"> <thead> <tr> <th>Für Brustpelotte</th> <th>a</th> <th>b</th> <th>c</th> </tr> </thead> <tbody> <tr> <td>108</td> <td>12 cm</td> <td>17 cm</td> <td>13 - 28 cm</td> </tr> <tr> <td>102</td> <td>14 cm</td> <td>20 cm</td> <td>19 - 33 cm</td> </tr> <tr> <td>101</td> <td>14 cm</td> <td>20 cm</td> <td>22 - 37 cm</td> </tr> </tbody> </table> <div style="border: 1px solid black; padding: 2px; display: inline-block;"><b>Nur in Kombination mit Rückenpelotte oder Brustpelotte (Code 10008-2)!</b></div>	Für Brustpelotte	a	b	c	108	12 cm	17 cm	13 - 28 cm	102	14 cm	20 cm	19 - 33 cm	101	14 cm	20 cm	22 - 37 cm	<b>Brustpelotte Sternum 108, inkl. Seitenführungspelotten</b> Code 1016843 breiten- und höhenverstellbar  <table border="1"> <thead> <tr> <th>a (Höhe Seitenführung)</th> <th>b (Tiefe)</th> <th>d (Höhe Brustpelotte)</th> <th>c (Brustkorbbreite)</th> </tr> </thead> <tbody> <tr> <td>11 cm</td> <td>13 cm</td> <td>17 cm</td> <td>21 - 28 cm</td> </tr> </tbody> </table>	a (Höhe Seitenführung)	b (Tiefe)	d (Höhe Brustpelotte)	c (Brustkorbbreite)	11 cm	13 cm	17 cm	21 - 28 cm
Für Gr.	a	b																																				
108	27 cm	24 cm																																				
102	32 cm	24 cm																																				
101	37 cm	30 cm																																				
Für Brustpelotte	a	b	c																																			
108	12 cm	17 cm	13 - 28 cm																																			
102	14 cm	20 cm	19 - 33 cm																																			
101	14 cm	20 cm	22 - 37 cm																																			
a (Höhe Seitenführung)	b (Tiefe)	d (Höhe Brustpelotte)	c (Brustkorbbreite)																																			
11 cm	13 cm	17 cm	21 - 28 cm																																			
<b>Stück</b> 202,-€	<b>Montage an der Brustpelotte</b> 223,-€ <b>Montage an der Rückenpelotte</b> 223,-€	<b>Stück</b> 367,-€																																				

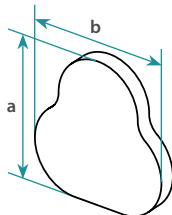
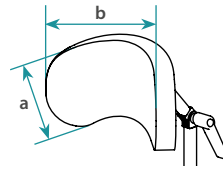
<b>Rückenpelotte</b> Code 10018  <table border="1"> <thead> <tr> <th>Für Gr.</th> <th>a</th> <th>b</th> </tr> </thead> <tbody> <tr> <td>108/102</td> <td>22 cm</td> <td>22 cm</td> </tr> <tr> <td>101</td> <td>27 cm</td> <td>27 cm</td> </tr> </tbody> </table>	Für Gr.	a	b	108/102	22 cm	22 cm	101	27 cm	27 cm	<b>Kopfstütze</b> Code 10034  <table border="1"> <thead> <tr> <th>Für Gr.</th> <th>a</th> <th>b</th> </tr> </thead> <tbody> <tr> <td>108</td> <td>12 cm</td> <td>24 cm</td> </tr> <tr> <td>102</td> <td>16 cm</td> <td>28 cm</td> </tr> <tr> <td>101</td> <td>20 cm</td> <td>30 cm</td> </tr> </tbody> </table> <div style="border: 1px solid black; padding: 2px; display: inline-block;"><b>Nur in Kombination mit einer Rückenpelotte möglich!</b></div>	Für Gr.	a	b	108	12 cm	24 cm	102	16 cm	28 cm	101	20 cm	30 cm
Für Gr.	a	b																				
108/102	22 cm	22 cm																				
101	27 cm	27 cm																				
Für Gr.	a	b																				
108	12 cm	24 cm																				
102	16 cm	28 cm																				
101	20 cm	30 cm																				
<b>Stück</b> 219,-€	<b>Stück</b> 267,-€																					

Weitere Anfertigungs- oder Anpassungswünsche:

---



---



---



---



---



---



---



---