

# Supine/Upright Stander Lasse Sizes 3G, 3 & 4 **REHATEC®**

Model 2020

*suitable from about 128 cm to about 180 cm*

## Cost estimate

Sender / billing address

## Order

Address for dispatch

Purchaser

Date

Commission

Configure your Lasse stander for teenagers and adults.

Our customer service is pleased to assist you with any questions.

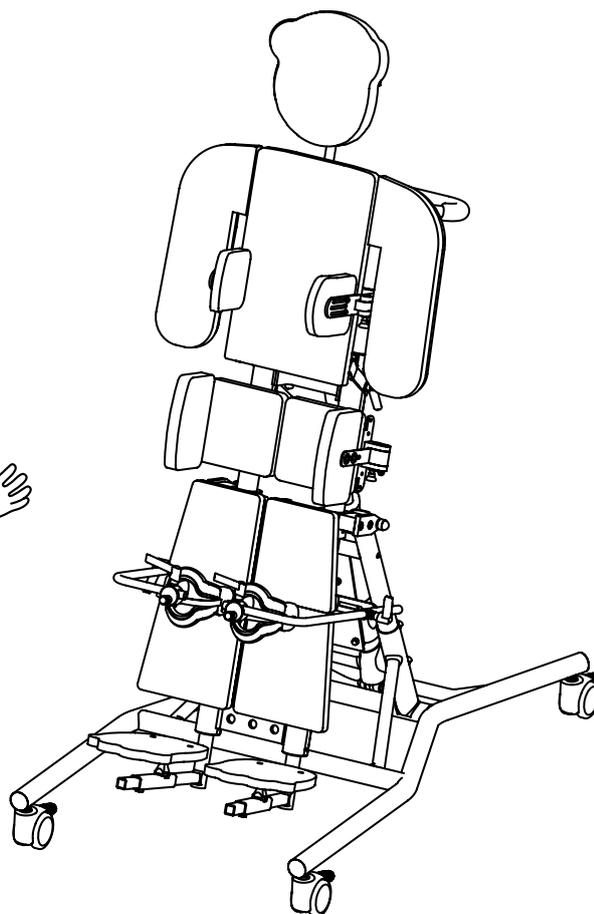
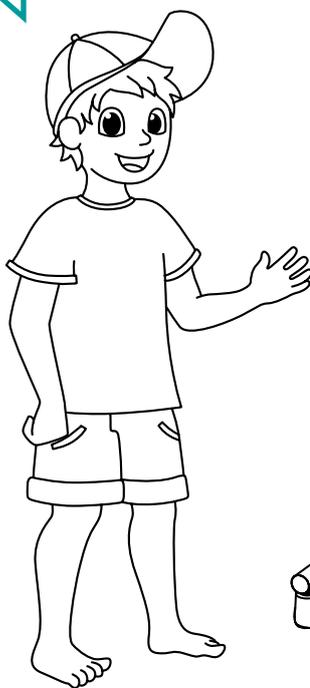

Figure does not comply with the base model and its accessories | Size tolerance of  $\pm 3\%$

### Base model 3G

- Frame with 75 mm castors
- Recline adjustment **via gas spring** with an angle range from 0° - 85°
- Split footplates
- Parted leg control pads
- Split pelvic support board incl. flip away pelvic supports
- Backrest
- Butterfly harness
- Push bar

### Base model 3 and 4

- Frame with 75 mm castors
- Recline adjustment **via electric motor** with an angle range from 0° to 85°
- Split footplates
- Parted leg control pads
- Split pelvic support board incl. flip away pelvic supports
- Backrest
- Butterfly harness

### Reimbursement code Germany

• Size 3G	28.29.02.1049
• Size 3	28.29.02.1049
• Size 4	28.29.02.1049

### Max. user weight

for size 3G: 60 kg  
for size 3: 70 kg  
for size 4: 70 kg

**Additional technical details available at [www.rehatec.com](http://www.rehatec.com) -> Downloads. Or send us your request by email, fax or letter.**

Valid from 2023-01-01 until recalled. © Unauthorized duplication without prior permission of Rehatec GmbH is strictly prohibited.

Technical changes reserved. Our General Terms and Conditions apply, see [www.rehatec.com](http://www.rehatec.com).

By ordering our products, you confirm that you have read and accepted our General Terms and Conditions

Rehatec® GmbH, In den Kreuzwiesen 35, 69250 Schönau, **T: +49 6228 9136-0, F: +49 6228 9136-99**, [info@rehatec.com](mailto:info@rehatec.com), [www.rehatec.com](http://www.rehatec.com)

Enter the measurements of your patient below.

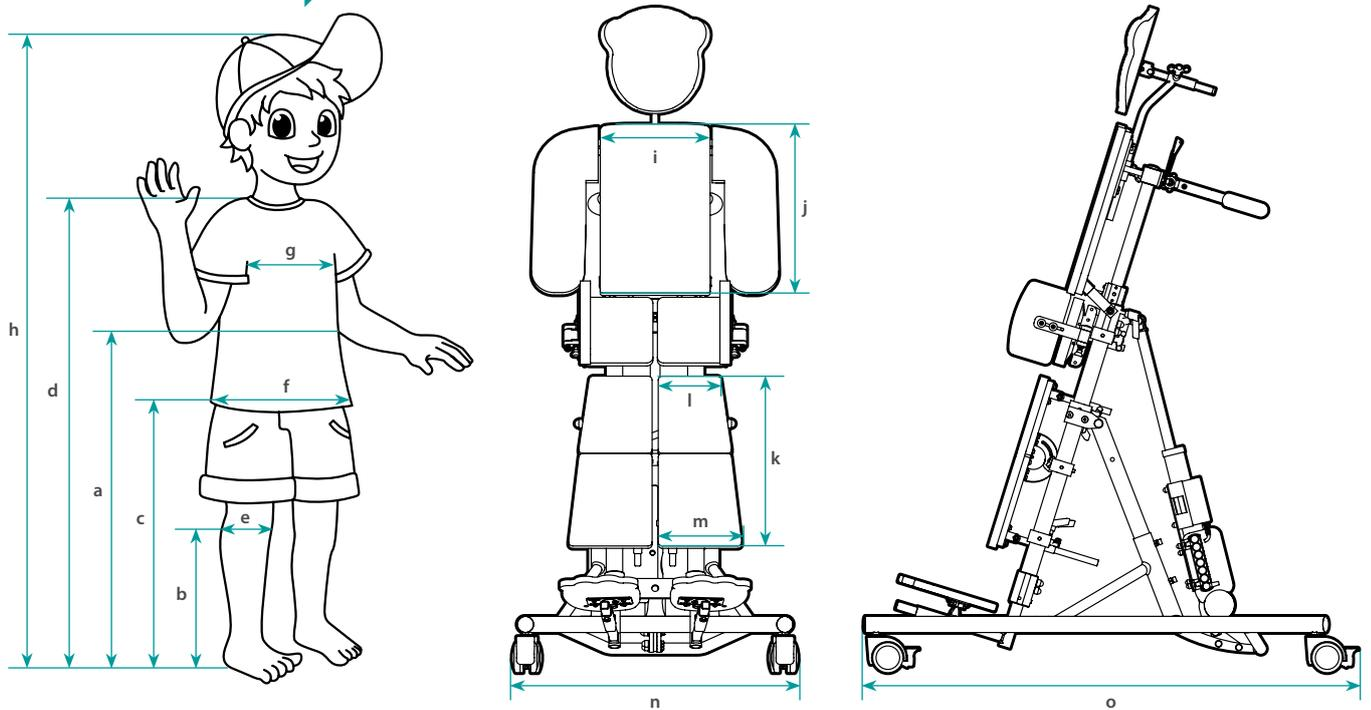

**Patient's muscle tone**  
Stereotypic movements (e.g. permanent body rocking)\*

Figure does not comply with the base model and its accessories | Size tolerance of ±3%

\*If there are stereotypic movements, please check whether the stander requires any special customisation.

User measurements				Please complete!					
	Tray height (a)	Knee height (b)	Pelvic middle (c)	Shoulder height (d)	Knee width (e)	Pelvic middle (f)	Chest width (g)	Body height (h)	User weight
Size 3G	80 – 110 cm	30 – 50 cm	ca. 65 – 78 cm	ca. 120 – 142 cm	8 – 13 cm	20 – 42 cm	22-36 cm (44 cm <sup>(1)</sup> )	ca. 128 – 162 cm	max. 60 kg
Size 3	70 – 110 cm	30 – 50 cm	ca. 55 – 76 cm	ca. 116 – 138 cm	8 – 13 cm	20 – 42 cm	22-36 cm (44 cm <sup>(1)</sup> )	ca. 124 – 158 cm	max. 70 kg
Size 4	80 – 120 cm	50 – 70 cm	ca. 70 – 90 cm	ca. 140 – 160 cm	8 – 13 cm	20 – 42 cm	22-36 cm (44 cm <sup>(1)</sup> )	ca. 148 – 180 cm	max. 70 kg
User	cm	cm	cm	cm	cm	cm	cm	cm	kg

<sup>(1)</sup> Optional accessories available (see page 5)

Base model measurements								
Type	Adjustment type	Back plate (i×j)	Leg control pads		Total width (n)	Total length (o)	Transfer height <sup>(1)</sup>	Clear space height <sup>(1)</sup>
			Height (k)	Width (l/m)				
3G	Gasfeder	27×44 cm	50 cm	15 cm / 20 cm	71 cm	122 cm	93 cm	14.5 cm
3	Motor	27×44 cm	44 cm	14 cm / 20 cm	71 cm	122 cm	84 cm	
4	Motor	27×53 cm	50 cm	14 cm / 20 cm	71 cm	122 cm	90 cm	

<sup>(1)</sup> 100 mm castors

Additional technical details available at [www.rehatec.com](http://www.rehatec.com) -> Downloads. Or send us your request by email, fax or letter.  
Valid from 2023-01-01 until recalled. © Unauthorized duplication without prior permission of Rehatec GmbH is strictly prohibited.  
Technical changes reserved. Our General Terms and Conditions apply, see [www.rehatec.com](http://www.rehatec.com).  
By ordering our products, you confirm that you have read and accepted our General Terms and Conditions  
Rehatec® GmbH, In den Kreuzwiesen 35, 69250 Schönau, T: +49 6228 9136-0, F: +49 6228 9136-99, info@rehatec.com, www.rehatec.com

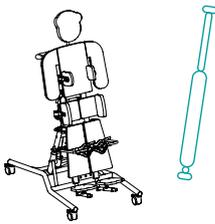
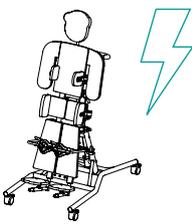
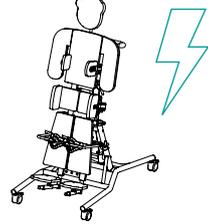
Versions		Frame	
<b>Supine/upright stander Lasse size 3G, adjustable via gas spring</b> Code 1020435 For children and teenagers <b>Recline adjustment via gas spring</b>		<b>Supine/upright stander Lasse size 3, adjustable via electric motor</b> Code 1007563 For children and teenagers <b>Recline adjustment via electric motor</b>	
<b>Supine/upright stander Lasse size 4, adjustable via electric motor</b> Code 1007005 For children and teenagers <b>Recline adjustment via electric motor</b>		<b>Battery for electric recline adjustment (emergency lowering function included)</b> Code 10072	
<b>Size 3G</b> <b>2.642,-€</b>	<b>Size 3</b> <b>4.528,-€</b>	<b>Size 4</b> <b>4.739,-€</b>	<b>Extra charge</b> <b>682,-€</b>

Cushion colours	
<b>Cushions for supporting surfaces/edges (premium Trevira® CS fabrics)</b>	
 Yellow / Grey	(GU700-S709)
 Pink / Grey	(GU702-S709)
 Red / Grey	(GU703-S709)
 Apple green / Grey	(GU705-S709)
 Light blue / Grey	(GU707-S709)
 Black / Grey	(GU710-S709)

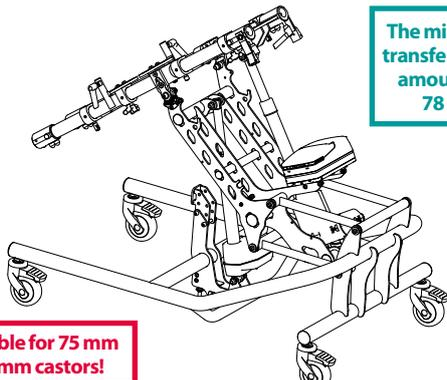
Electric height/recline adjustment							
<b>Electric height/recline adjustment, battery included</b> <b>100 mm castors and degree indicator</b>							
	<div style="border: 1px solid black; padding: 5px; width: fit-content;">                     The minimum transfer height amounts to 78 cm.                 </div>						
<div style="border: 1px solid red; padding: 5px; width: fit-content; margin: 5px auto;"> <b>Not available for 75 mm and 125 mm castors!</b> </div>							
<table border="1"> <thead> <tr> <th>Code</th> <th>for size</th> </tr> </thead> <tbody> <tr> <td>1024412</td> <td>3</td> </tr> <tr> <td>1024925</td> <td>4</td> </tr> </tbody> </table>	Code	for size	1024412	3	1024925	4	<div style="border: 1px solid black; padding: 5px; width: fit-content;"> <b>Lasse size 3G is not available with height/recline adjustment!</b> </div>
Code	for size						
1024412	3						
1024925	4						
<b>Extra charge</b>	<b>1.490,-€</b>						

**Do not forget to select the frame and cushion colours of your Lasse. They are very important to process your order.**



Frame colours			
 Pure white	(RAL 9010)	 Claret violet	(RAL 4004)
 Daffodil yellow	(RAL 1007)	 Ultramarine blue	(RAL 5002)
 Luminous yellow	(RAL 1026)	 Metallic traffic blue*	
 Pure orange	(RAL 2004)	 Pearl night blue, matt	(RAL 5026)
 Luminous orange	(RAL 2005)	 Water blue	(RAL 5021)
 Ruby red	(RAL 3003)	 Light green	(RAL 6027)
 Pearl ruby red, matt	(RAL 3032)	 Yellow green	(RAL 6018)
 Heather violet	(RAL 4003)	 Pearl green, matt	(RAL 6035)
		 Luminous green	(RAL 6038)
		 Anthracite grey, matt	(RAL 7016m)
		 Metallic silver*	
		 Metallic anthracite*	
		 Graphite black, matt	(RAL 9011m)
		 Glossy jet black	(RAL 9005g)

\*no RAL colours

**This is only an overview of colours. Find all details at [www.rehatec.com](http://www.rehatec.com).**

Additional technical details available at [www.rehatec.com](http://www.rehatec.com) -> Downloads. Or send us your request by email, fax or letter.

Valid from 2023-01-01 until recalled. © Unauthorized duplication without prior permission of Rehatec GmbH is strictly prohibited.

Technical changes reserved. Our General Terms and Conditions apply, see [www.rehatec.com](http://www.rehatec.com).

By ordering our products, you confirm that you have read and accepted our General Terms and Conditions

Rehatec® GmbH, In den Kreuzwiesen 35, 69250 Schönau, T: +49 6228 9136-0, F: +49 6228 9136-99, info@rehatec.com, www.rehatec.com

# Castors & Supports

Supine/Upright Stander Lasse sizes 3G, 3 and 4 – Model 2020

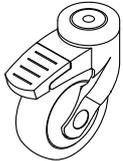
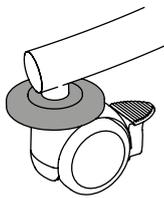
Castors		Lockable 100 mm castors	Lockable 125 mm castors	Wall and furniture bumpers							
<b>Lockable castors , 75 mm</b> Clear space height = 10 cm  <div style="border: 1px solid red; padding: 2px; color: red; font-weight: bold;">Not available for height adjustable frame!</div>	<b>Lockable 100 mm castors</b> Code 1022143 Clear space height = 14.5 cm 	<b>Lockable 125 mm castors</b> Clear space height = 17 cm  <div style="border: 1px solid red; padding: 2px; color: red; font-weight: bold;">Not available for height adjustable frame!</div>	<b>Wall and furniture bumpers</b> <div style="border: 1px solid teal; padding: 2px; color: teal; font-weight: bold;">The total width extends by 4 cm!</div>  <table border="1" style="font-size: small;"> <thead> <tr> <th>Code</th> <th>Castors</th> </tr> </thead> <tbody> <tr> <td>1018607</td> <td>75 mm</td> </tr> <tr> <td>1018783</td> <td>100 mm</td> </tr> <tr> <td>1018698</td> <td>125 mm</td> </tr> </tbody> </table>	Code	Castors	1018607	75 mm	1018783	100 mm	1018698	125 mm
Code	Castors										
1018607	75 mm										
1018783	100 mm										
1018698	125 mm										
<b>Standard</b>	<b>Extra charge</b>	<b>96,-€</b>	<b>Optional</b>	<b>Set</b>	<b>111,-€</b>						

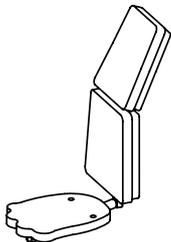
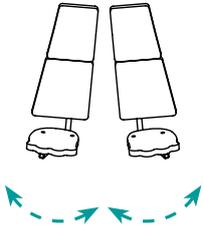
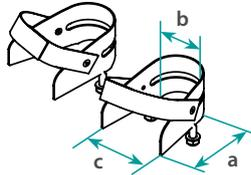
Leg positioning		Individual leg abduction	Sandals, foot straps included							
<b>Leg positioning, adjustable for angle</b> Code 10047 	<b>Individual leg abduction</b> Code 10073-1 From 0° to 25°  <div style="border: 1px solid teal; padding: 2px; color: teal; font-weight: bold;">Multi-adjustable footrests included</div>	<b>Sandals, foot straps included</b> Code 10052  <table border="1" style="font-size: small;"> <thead> <tr> <th>For size</th> <th>a</th> <th>b</th> <th>c</th> </tr> </thead> <tbody> <tr> <td>3G / 3 / 4</td> <td>14 cm</td> <td>9 cm</td> <td>11 cm</td> </tr> </tbody> </table>	For size	a	b	c	3G / 3 / 4	14 cm	9 cm	11 cm
For size	a	b	c							
3G / 3 / 4	14 cm	9 cm	11 cm							
<b>Pair/Extra charge</b>	<b>448,-€</b>	<b>Extra charge</b>	<b>822,-€</b>	<b>Pair/Extra charge</b>	<b>170,-€</b>					

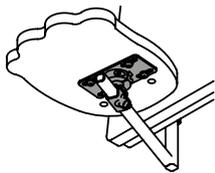
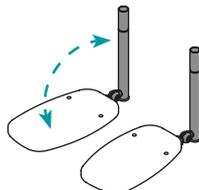
Leg positioning		Multi-adjustable ball joints for split footplates	Footplate attachment, adjustable for angle
<b>Multi-adjustable ball joints for split footplates</b> Code 10051 to support foot flexion, extension, supination and pronation  <div style="border: 1px solid teal; padding: 2px; color: teal; font-weight: bold;">CAUTION! Specified user measurements (c) + (d) + (h) are reduced by 4 cm!</div>	<b>Footplate attachment, adjustable for angle</b> Code 1020344 Adjustable via toothed segments 		
<b>Pair/Extra charge</b>	<b>271,-€</b>	<b>Pair/Extra charge</b>	<b>290,-€</b>

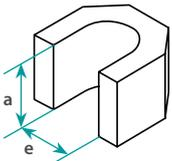
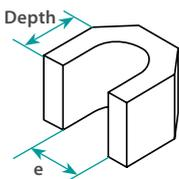
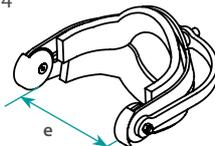
Knee cups		Knee cups made to measure	Knee cups, contoured	Mechanical stop, knee depth adjustment																			
<b>Knee cups</b> Code 10045  <table border="1" style="font-size: small;"> <thead> <tr> <th></th> <th>e (knee width)</th> <th>a</th> </tr> </thead> <tbody> <tr> <td>1</td> <td>7 cm</td> <td>9 cm</td> </tr> <tr> <td>2</td> <td>8 cm</td> <td>10 cm</td> </tr> <tr> <td>3</td> <td>9 cm</td> <td>12 cm</td> </tr> </tbody> </table>		e (knee width)	a	1	7 cm	9 cm	2	8 cm	10 cm	3	9 cm	12 cm	<b>Knee cups made to measure</b> Code 10045-2  Depth = _____ cm Width: e = _____ cm	<b>Knee cups, contoured</b> Code 10074  <table border="1" style="font-size: small;"> <thead> <tr> <th></th> <th>e (knee width)</th> </tr> </thead> <tbody> <tr> <td>1</td> <td>8 cm</td> </tr> <tr> <td>2</td> <td>11.5 cm</td> </tr> <tr> <td>3</td> <td>13 cm</td> </tr> </tbody> </table>		e (knee width)	1	8 cm	2	11.5 cm	3	13 cm	<b>Mechanical stop, knee depth adjustment</b> Code 1023378 
	e (knee width)	a																					
1	7 cm	9 cm																					
2	8 cm	10 cm																					
3	9 cm	12 cm																					
	e (knee width)																						
1	8 cm																						
2	11.5 cm																						
3	13 cm																						
<b>Pair</b>	<b>Pair</b>	<b>Pair</b>	<b>Pair</b>																				
<b>Please choose one!</b>	<b>Please choose one!</b>	<b>Please choose one!</b>																					
<b>503,-€</b>	<b>695,-€</b>	<b>567,-€</b>	<b>30,-€</b>																				

Additional technical details available at [www.rehatec.com](http://www.rehatec.com) -> Downloads. Or send us your request by email, fax or letter.

Valid from 2023-01-01 until recalled. © Unauthorized duplication without prior permission of Rehatec GmbH is strictly prohibited.

Technical changes reserved. Our General Terms and Conditions apply, see [www.rehatec.com](http://www.rehatec.com).

By ordering our products, you confirm that you have read and accepted our General Terms and Conditions

Rehatec® GmbH, In den Kreuzwiesen 35, 69250 Schönau, T: +49 6228 9136-0, F: +49 6228 9136-99, info@rehatec.com, www.rehatec.com

# Pelvis, Tray & Thoracic Supports

Supine/Upright Stander Lasse sizes 3G, 3 and 4 – Model 2020

## Pelvic supports

### Split pelvic support board, flip away pelvic supports

#### Angled 50 mm mounting bracket

For size	a	b	f (pelvic width)
3G / 3 / 4	19 cm	12 cm	20 - 25 cm

#### Angled 25 mm mounting bracket

For size	a	b	f (pelvic width)
3G / 3 / 4	19 cm	12 cm	25 - 30 cm

#### Straight mounting bracket

For size	a	b	f (pelvic width)
3G / 3 / 4	19 cm	12 cm	30 - 35 cm

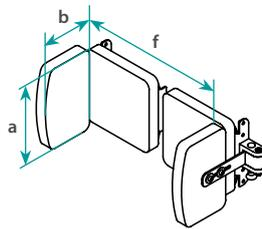

### Pelvic support board, flip away pelvic supports

Code 1010994

#### Straight mounting bracket

For size	a	b	f (pelvic width)
3G / 3 / 4	19 cm	12 cm	32 - 42 cm

#### Angled mounting bracket

For size	a	b	f (pelvic width)
3G / 3 / 4	19 cm	12 cm	22 - 32 cm

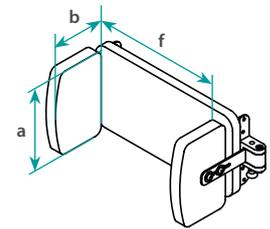

Standard

**Please choose one!**

Extra charge

**Please choose one!**

310,-€

## Tray

### Tray with bowl, cover and grab rail

Adjustable for depth and angle

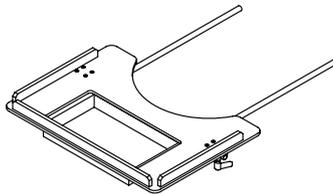

	Code
3	1009919
4	1010528

### Tray with grab rail

Adjustable for depth and angle

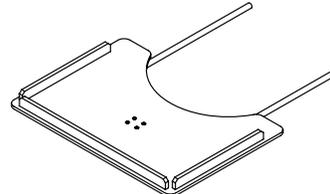

	Code
3	1007227
4	1007378

### Mechanical stop (adjusting ring) tray depth adjustment

Code 1023148



Extra charge

895,-€

Extra charge

728,-€

Pair

30,-€

## Thoracic supports

### Lateral supports

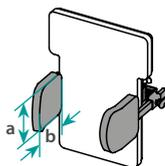

Supports	Code	a	b
Flip away	10041	12 cm	14 cm
Removable	10041-1	12 cm	14 cm

Flip away 293,-€  
Removable 293,-€

### Armrests, removable

Code 10042

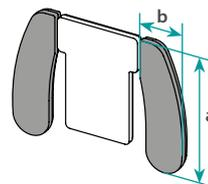

	a	b
3	43 cm	16 cm
4	37 cm	16 cm

Pair 336,-€

## Push bar

### Push bar

Code 10076

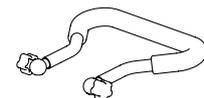

Part of Lasse 3G base model!

Extra charge 320,-€

## Optional accessories

### Angled 40 mm mounting bracket for lateral supports

Code 1013993

For size	Chest width (g)
3G	22 - 44 cm
3	22 - 44 cm
4	22 - 44 cm

Pair 120,-

### Mounting bracket for armrests, extended

Code 1010871

Mounting bracket required for a chest width exceeding 36 cm!

Pair 67,-

Additional technical details available at [www.rehatec.com](http://www.rehatec.com) -> Downloads. Or send us your request by email, fax or letter.

Valid from 2023-01-01 until recalled. © Unauthorized duplication without prior permission of Rehatec GmbH is strictly prohibited.

Technical changes reserved. Our General Terms and Conditions apply, see [www.rehatec.com](http://www.rehatec.com).

By ordering our products, you confirm that you have read and accepted our General Terms and Conditions

Rehatec® GmbH, In den Kreuzwiesen 35, 69250 Schönau, T: +49 6228 9136-0, F: +49 6228 9136-99, info@rehatec.com, www.rehatec.com

